





## The origin of CROPS

“To harvest crops” --Thinking of crops in the context of agriculture.

Seeds are sown. They take root and grow. With great care and labor the farmers harvest the crops.

We assemble new and unique ideas.

We select those that merit our attention and design consideration.

We Innovate, simplify, and craft products that carry our name.

CROPS was founded in 1996 based on this conceptual metaphor.

### CROPS—Our Ideas

Our crops, in other words our products, are well-developed,

This is due to the efforts of our outstanding designers, technicians and manufacturers.

We want to provide products that amaze and delight the user.

### CROPS—Our design

The appearance isn't anything outrageous.

The essence = simplicity

We strive to apply our design philosophy across our product line. Easy to use designs that exhibit simple, functional beauty.

### CROPS—Our craftsmanship

Our team works in close collaboration with local technicians and manufacturers.

Through mutual trust we are able to pursue product designs and follow processes that will yield a quality CROPS product.

Attention to the smallest details and continuous improvement of the design is part of our process.

We'll produce prototypes based on our initial designs. We'll field test them to evaluate form, fit, and function.

We'll refine the design using real world feed-back. Through these iterations, we can fully develop and proudly deliver CROPS products.

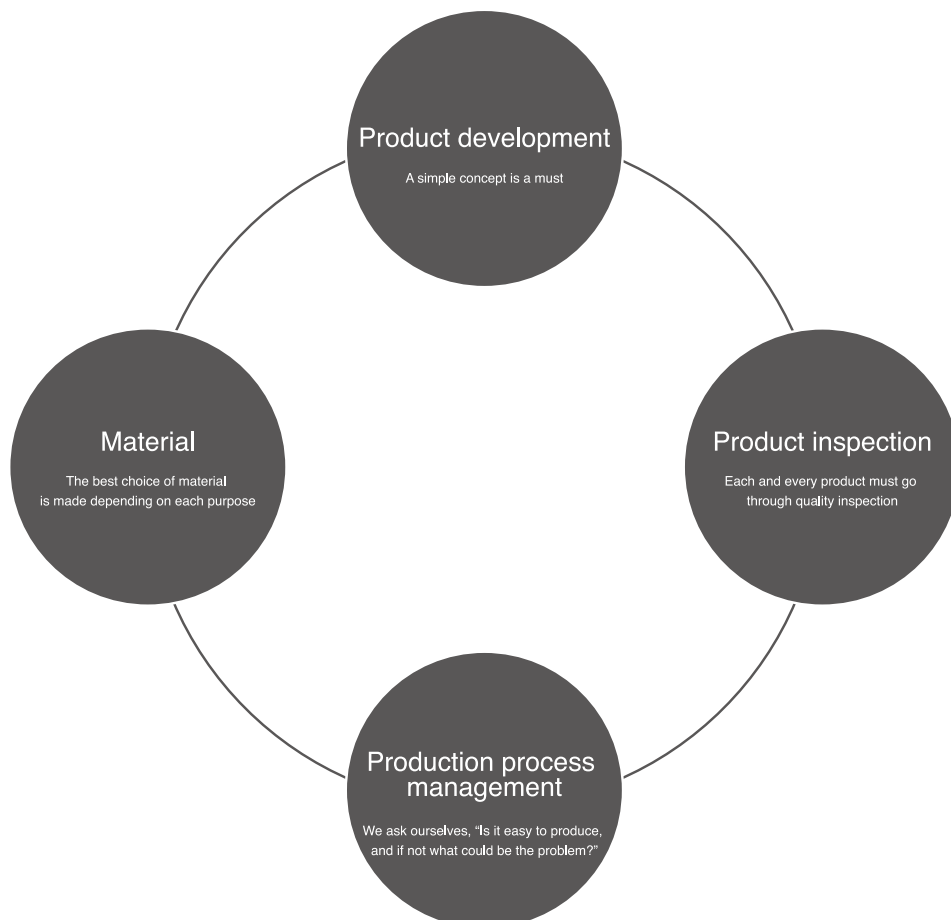

# Product concept



The CROPS flagship model beats others in attractiveness.  
When we make our locks, we begin with designing cylinders.  
The rigidness is present, and yet a shaped head is made possible.  
Not only does it protect your bicycle from theft, it's easy to use and  
also feels comfortable when you push the key into the lock.  
Each time you use the key, you feel a sense of satisfaction.  
This is what CROPS Pro Series is all about.



With our main products being locks and lights,  
we offer general bicycle accessories.  
We have products of varied specifications and colors to meet your needs  
in all cycling environments from road racing to urban cycling.  
Our product lineup will satisfy cyclists of any kind,  
whether he/she is a road racer or an urban cyclist.







CROPS PRO / ADVANCE  
**LOCKS**



## Vibration sensor alarm **LION ALARM**



	Product code	Color	Type	Weight (g)
Single	CP-Z110-AL	Black	ALARM	130

Parts : USB (Type-C) cable



- Switch for
- On / Off
  - Volume control
  - Battery status check



# LION ALARM, linkstation combo

It can be used on bicycle frames that are equipped with bottle cage mounts.  
 The LION ALARM can be mounted directly to the bicycle,  
 and when vibration is detected, the alarm sounds.

Constant : Approx 160hrs. (In ON mode)

Constant alert : Approx 22hrs.  
 (Repeat alert for every 10sec.)

Full charge : Approx 2hrs.



Product code	Color	Type	Weight (g)
Combo CP-Z110-LNK-AL	Black	ALARM	130 250

Parts : Dimple keys x 3 / USB (Type-C) cable / Spacer / Screw



## K4 ATTACHMENT PARTS K4 Connector link

Product code	Color	Type	Weight (g)
ZP-K4-CNL	Silver	Attachment	33



## K4 Single terminal straight cable

Product code	Color	Cable size (φ x Lmm)	Cable type	Weight (g)
ZP-K4-STL8150	Black	8 (Single) x 1500	Straight cable	285



Option  
 K4 Single terminal straight cable

## K4 Double terminal coiled cable

Product code	Color	Cable size (φ x Lmm)	Cable type	Weight (g)
ZP-K4-DTL10110	Black	10 (Single) x 1100	Coiled cable	311



Option  
 K4 Double terminal coiled cable

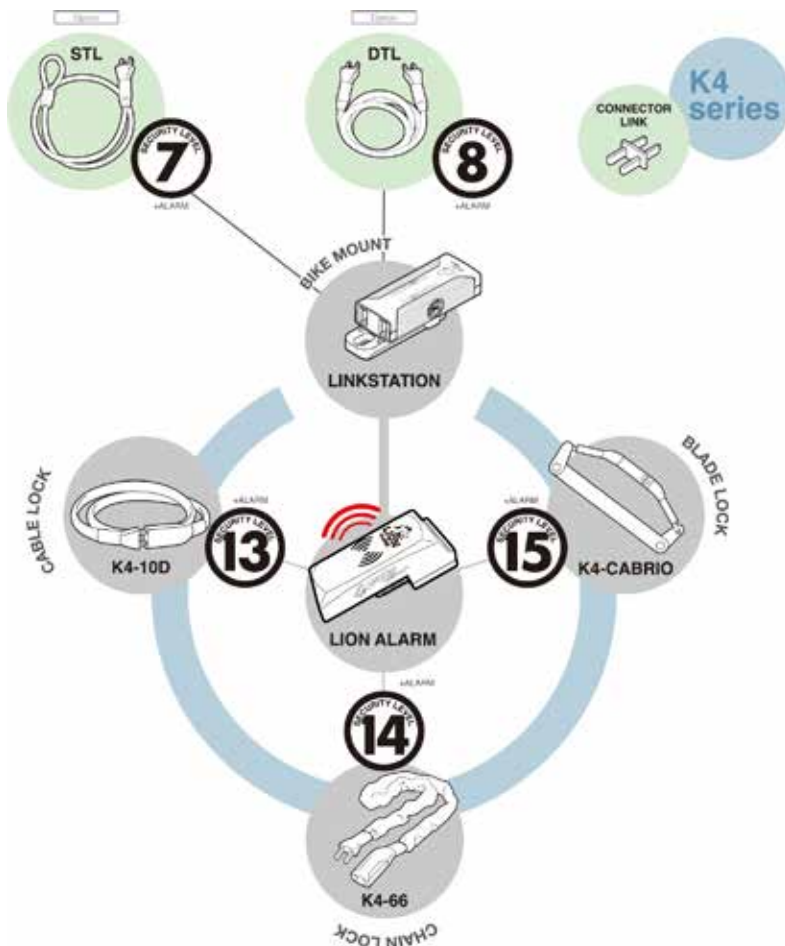



**K4**  
CABRIO

## K4-CABRIO



	Product code	Color	Size (T x L mm)	Size (pipe diameter mm)	Type	Weight (g)
Combo	K4-FD60NB-AL	Black	6 x 800	φ25~38	Blade	750

Parts : Dimple keys x 3  
 Bracket "ZP-BKT007K" /  
 Strap x 2 / Phillips head screws x 2  
 USB (Type-C) cable

[ LION ALARM ]  
 Constant : Approx 160hrs. (In ON mode)  
 Constant alert : Approx 22hrs. (Repeat alert for every 10sec.)  
 Full charge : Approx 2hrs.

	Product code	Color	Size (T x L mm)	Size (pipe diameter mm)	Type	Weight (g)
Single	K4-FD60NB-01	Black	6 x 800	φ25~38	Blade	620

Parts : Dimple keys x 3  
 Bracket "ZP-BKT007K" / Strap x 2 / Phillips head screws x 2

	Product code	Color	Type	Weight (g)
Single	CP-Z110-AL	Black	ALARM	130

Parts : USB (Type-C) cable



**K4**  
CABRIO

## K5-CABRIO



	Product code	Color	Size (T x L mm)	Size (pipe diameter mm)	Type	Weight (g)
	K5-FD60NB-01	Black	6 x 800	φ25~38	Blade	590

Parts: Bracket "ZP-BKT007K" / Strap x 2 / Phillips head screws x 2



**K5**  
CABRIO



# FOLDABLE U-LOCK benlock™

**“BENLOCK” is sturdy and portable  
the latest foldable U-lock.**



**THE BRACKET DESIGNED WITH  
SMART TAG STORAGE SPACE**

In addition, the smart tag can be hidden in a special case to provide the most advanced security measures. The BENLOCK™ bracket can be mount to the bicycle body, concealing the smart tag in a hidden location.



-Break through the common sense of bicycle locks-  
“BENLOCK™” which is sturdy and portable! the latest foldable U-lock.  
The key to choosing a lock is the balance of weight, ease of handling, and security performance. The stronger the lock, the better the security performance, but the lock is proportionally heavier and harder to handle. As a result of pursuing both strength and ease of handling, it became a very well- balanced lock, which is the “BENLOCK™” . There have been many cases of people finding and returning stolen cars because they had GPS tracking system installed. The BENLOCK™ can equipped with a smart tag into the bracket which is the most advanced anti-theft measures to protect your valuable bicycles.



**GOOD DESIGN  
AWARD 2023**



## BENLOCK BRACKET COMBO



Product code	Color	Size (WxDxL mm)	Size (pipe diameter mm)	Type	Weight (g)
BEN-FD15B-01	Black	127x24.5x197	φ25~38	U-LOCK	537

Parts : Bracket “ZP-BKT007” / Strap x 2 / Phillips head screws x 2

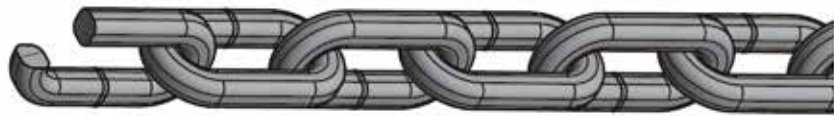
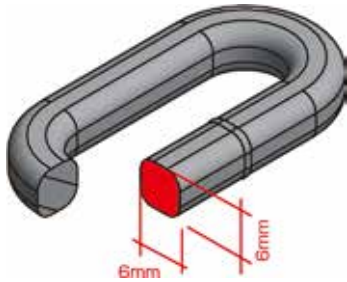

### The angled chain

Characteristics and strength  
Strong steel chain specially heat-treated for reinforcement.

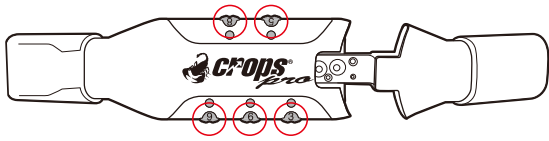

### A 5-digit combination lock ( Head type : K5 )

The CROPS original double-locking system which uses two balls locking into two blades defies the traditional locking systems. The unique 5-digit combination lock is equally spaced and lined up flat for precise setting. You won't get annoyed by accidentally turning other dials while using, unlike what happens with the ordinary 5-digit combination locks.

### The Dimple key ( Head type : K4 )

The supplied dimple key is slightly bigger than a regular key so it fits comfortably in your hand.

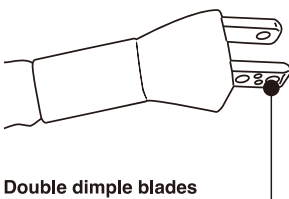

**Double dimple blades**  
Anti-twist double blades  
Designed for very smooth insertion.

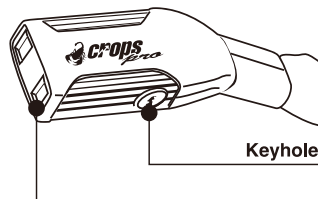

**Connecting part for K4 series**  
Enables connection to optional K4 series.



ART\*\*Approved

## Deflocker



Product code	Color	Chain size (T x Lmm)	Chain type	Weight (g)
DL8-900-01	Black	8 x 900	Chain	2040

Parts : Dimple keys x 3(For disk type cylinder)

## K5-66



.5

Product code	Color	Chain size (T x Lmm)	Chain type	Weight (g)
CP-K5-66-01	Black	6 x 1100	Angled chain	1030



## K5-66

## K4-66



.5

Combo

Single

	Product code	Color	Chain size (T x Lmm)	Chain type	Weight (g)
Combo	CP-K4-66-AL-01	Black	6x1100	Angled chain	1178

Parts : Dimple keys x 3  
 USB (Type-C) cable

[ LION ALARM ]  
 Constant : Approx 160hrs. (In ON mode)  
 Constant alert : Approx 22hrs. (Repeat alert for every 10sec.)  
 Full charge : Approx 2hrs.

	Product code	Color	Chain size (T x Lmm)	Chain type	Weight (g)
Single	CP-K4-66-01	Black	6 x 1100	Angled chain	1048

Parts : Dimple keys x 3

	Product code	Color	Type	Weight (g)
Single	CP-Z110-AL	Black	ALARM	130

Parts : USB (Type-C) cable







## K4-10D



	Product code	Color	Cable size (φ×Lmm)	Cable type	Weight (g)
Combo	K4-10D110-AL	Black	10(Double)×1100	Straight cable	742
	K4-10D180-AL	Black	10(Double)×1800	Straight cable	931

Parts : Dimple keys x 3 [ LION ALARM ]  
 USB / Type-C cable Constant : Approx 160hrs. (In ON mode)  
 Constant alert : Approx 22hrs. (Repeat alert for every 10sec.)  
 Full charge : Approx 2hrs.

	Product code	Color	Cable size (φ×Lmm)	Cable type	Weight (g)
Single	CP-K4-10D110	Black	10(Double)×1100	Straight cable	612
	CP-K4-10D180	Black	10(Double)×1800	Straight cable	801

Parts : Dimple keys x 3

	Product code	Color	Type	Weight (g)
Single	CP-Z110-AL	Black	ALARM	130

Parts : USB / Type-C cable



CP-K4-10D110



CP-K4-10D180



# K5-10D



Product code	Color	Cable size (φ×Lmm)	Cable type	Weight (g)
CP-K5-10D110	Black	10(Double)×1100	Straight cable	547
CP-K5-10D180	Black	10(Double)×1800	Straight cable	795

# K5



CP-K5-10D110



CP-K5-10D180

# K5



Product code	Color	Cable size (φ×Lmm)	Cable type	Weight (g)
CP-K5-10180	Black	10(Single)×1800	Coiled cable	506

Parts : Universal bracket " ZP-BKT006N "



## Why do double wired cable provide excellent security?

When attempting to cut the double wired cable with tools such as pliers, wire ② cannot reach the blade near the pivot where the cutting force is greatest, and this wire ② gets in the way, thus making it difficult for wire ① to be cut.

※Proven to show the above result when using small tools such as pliers or nippers. The same results may not be anticipated when using bolt clippers or wire cutters.

Cross-section of the double wired cable

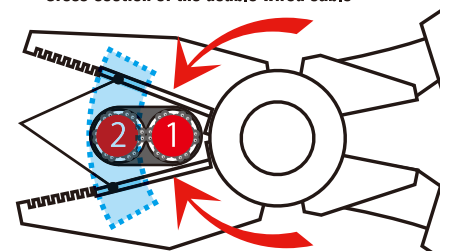



## K5-BIRO 150



**K5  
BIRO**

Product code	Color	Cable size (φ x L mm)	Cable type	Weight (g)
K5-BR150B-01S	Black	Overall length 1500mm 4mm Steel cables	Memory shape cable	299

Parts : Bracket "ZP-BKT006N"



## K4-BIRO 150



**K4  
BIRO**

Product code	Color	Cable size (φ x L mm)	Cable type	Weight (g)
K4-BR150B-01S	Black	Overall length 1500mm 4mm Steel cables	Memory shape cable	331

Parts : Dimple keys x 3 / Bracket "ZP-BKT006N"





The most secure model in the CROPS Compact series. The double wire structure helps resist cutting, and it is designed balancing the best in portability and strength. It is easy to bundle since the cross section is elliptical when stored.

## Q10



Product code	Color	Cable size (φ × L mm)	Cable type	Weight (g)
CP-SPD10-01	Black	5 (Double) × 1500	Straight cable	185
CP-SPD10-07	Titanium silver			

**Q10**  
STRAIGHT CABLE



## Q5



Product code	Color	Cable size (φ × L mm)	Cable type	Weight (g)
CP-SPD09-01	Black	5 (Single) × 1800	Straight cable	148
CP-SPD09-02	White			

**Q5**  
STRAIGHT CABLE



Option

# Q5-Easy Wrap



Product code	Color	Cable size (φ x Lmm)	Cable type	Weight (g)
CP-SPD09-EW-01	Black			
CP-SPD09-EW-02	White	5 (Single) x 1800	Straight cable with coiled neck	165
CP-SPD09-EW-04	Red			



Option

Option

## Q5 EasyWrap

Easy wrap for easy storage

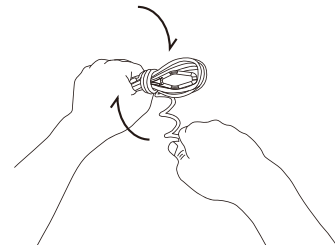

← 1800mm → +600mm →



# Q5-COCON



Product code	Color	Cable size (φ × Lmm)	Cable type	Weight (g)
SPD09-CCN-01	Black			
SPD09-CCN-04	Red			
SPD09-CCN-05	Yellow	5 (Single) × 1800	Coiled cable	148
SPD09-CCN-17	Gray			
SPD09-CCN-31	Indigo blue			



# Q<sup>5</sup> COCON







CROPS  
**LOCKS**





**VERSATILE CARABINER STYLE**

The outer opening gate is compact, yet can hook and lock thick objects. It can be used not only as a lock for bicycles, but also to prevent theft of motorcycle helmets and in outdoor scenes. With a 3mm coil cable, the lock can be used in a variety of ways depending on your ideas.

**ELK**



Product code	Color	Cable size (φ × Lmm)	Cable type	Weight (g)
SPD03-SC01-01	Black			
SPD03-SC01-04	Red	3 (Single) × 1500	Coiled cable	111
SPD03-SC01-27	Hairline silver			

MAIN-GATE

SUB-GATE



**ELK**  
THE HOOK LOCK





## K2 CHAIN LOCK



Product code	Color	Chain size (φ × Lmm)	Chain type	Weight (g)
K2-50-01	Black	3 × 500	Steel chain	237
K2-100-01	Black	3 × 1000	Steel chain	323



**K2**  
CHAIN LOCK



K2-50-01



K2-100-01

## K3-BIRO



Product code	Color	Cable size (φ × Lmm)	Cable type	Weight (g)
K3-BR120B-01	Black			
K3-BR120B-04	Red	4 (Double) × 1200	Memory shape cable	200
K3-BR120B-91	CARBON			

Parts : Universal bracket " ZP-BKT006N "



**K3**  
BIRO



MULTI PURPOSE



A versatile lock for various needs

**Q**  
**BIRO**  
*mini*



**Q-BIRO mini**



Product code	Color	Cable size (φ × Lmm)	Cable type	Weight (g)
SPD04-BR90-01	Black			
SPD04-BR90-04	Red	2 (Double) × 900	Memory shape cable	84
SPD04-BR90-31	Indigo blue			





## Q BIRO



### Q-BIRO



Product code	Color	Cable size (φ × Lmm)	Cable type	Weight (g)
CP-SPD04-BR-01	Black			
CP-SPD04-BR-02	White			
CP-SPD04-BR-04	Red	2 (Double) × 1800	Memory shape cable	111
CP-SPD04-BR-31	Indigo blue			



# COMPACT



Q3



Product code	Color	Cable size (φ × Lmm)	Cable type	Weight (g)
CP-SPD08-01	Black			
CP-SPD08-02	White			
CP-SPD08-04	Red	3 (Single) × 1800	Coiled cable	93
CP-SPD08-33	Gravel green			
CP-SPD08-34	Gravel sand			



Q<sup>3</sup>  
COIL  
CABLE





## SPIDER



Product code	Color	Cable size (φ x Lmm)	Cable type	Weight (g)
CP-SPD02-01	Black	2.5 (Single) x 1800	Coiled cable	63
CP-SPD02-02	White			

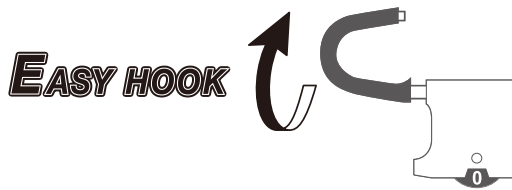

## SPIDER



Option



# CAFE LOCK



**EXTENSIBLE CABLE**  
MAX L 2400 mm

**Easy Wrap**  
EASY CABLE STORAGE

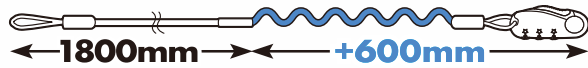

**LONG CABLE**  
L 1800 mm

## Q4-Easy Wrap



Product code	Color	Cable size (φ x Lmm)	Cable type	Weight (g)
CP-SPD07-EW-01	Black			
CP-SPD07-EW-02	White	4(Single) x 1800	Straight cable with coiled neck	136
CP-SPD07-EW-04	Red			



## Q4



Product code	Color	Cable size (φ x Lmm)	Cable type	Weight (g)
CP-SPD07-01	Black			
CP-SPD07-02	White			
CP-SPD07-04	Red	4(Single) x 1800	Straight cable	123
CP-SPD07-33	Gravel green			
CP-SPD07-34	Gravel sand			



## SHORT CABLE L 300 mm

## uni Q 30cm



### UNI Q



Product code	Color	Cable size (φ x Lmm)	Cable type	Weight (g)
CP-SPD07SHT-01	Black			
CP-SPD07SHT-02	White			
CP-SPD07SHT-04	Red			
CP-SPD07SHT-17	Gray	4 (Single) x 300	Straight cable	71
CP-SPD07SHT-18	Mango			
CP-SPD07SHT-33	Gravel green			
CP-SPD07SHT-34	Gravel sand			



**Dimple key**



K4 series

**Dimple key type**

Alarm "LION ALARM" with built-in vibration sensor can be connected. The head shape like an outlet plug boasts high security by having an independent locking mechanism for each of the two blades.

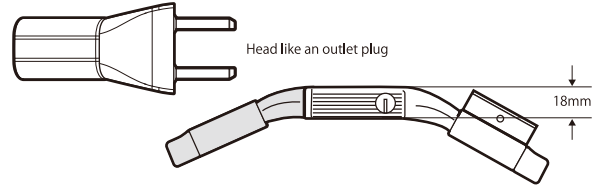

**Combination lock**



**Combination lock**

Design that balances function and design in a flat, easy-to-turn arrangement



**Zero stop counter**

Turn the dial clockwise to stop at "0". Because it can be set to "0" quickly, it is easy to count to the number when unlocking.



K5 series

**5-digit combination lock**

You can set 100,000 Pins, and by arranging the five-digit combination flat, it is easy to visually remember the PIN and easy to operate when turning the dial.

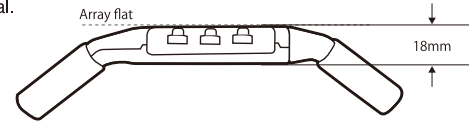

K3

**3-digit combination lock**

It is a lightweight and practical head specification in a sharp form pursuing a comfortable usability.

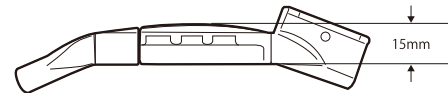

K2 series

**3-digit combination lock**

"K2" 3 digits combination cylinder with smooth and stress-free to lock and unlock.

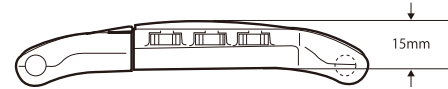

Q5 series / Q10

**3-digit combination lock**

PRO spec head that further enhances the "Q series" head. This sizing fits most hands and is suitable for various scenes required for urban riding.



Q series

**3-digit combination lock**

Head that can be said to be a representative work of CROPS developed for road bike users. It has been embraced by users for its functionality and variations.

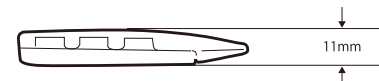

SPIDER

**3-digit combination lock**

The flat construction of the head and the wide-opening shackle allows versatile use.

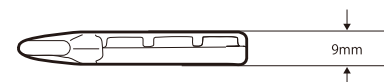



**CABLE LENGTH COMPARISON**

[Lock front wheel and down tube]  
Cable length comparison

**Cable : L 300 mm**



[Lock the front wheel and down tube]

**Cable : L 1100 mm**

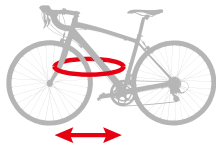

[Locked on fences such as bicycles and bicycle parking lots]

**Cable : L 1800 mm**

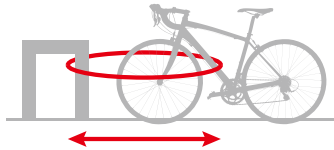

**BLADE**

6mm thick quenching blades are connected with special rivets, resistant to cutting and bending, and have strength for long-term bicycle parking.



**CHAIN**

Uses a high-strength hardened steel chain. 3mm, 4mm, 6mm, 8mm series development.



**BIG BIRO CABLE**

Specs that further reinforce the BIRO cable and have a good balance between strength and portability. Used in bracket-fixed K3-BIRO, K4-BIRO, etc.



**BIRO CABLE**

BIRO cable (shape memory cable) made by CROPS original manufacturing method is harder to stretch than a normal coil cable, and it has double wire strength.



**COILED CABLE**

It does not need to be bundled when stored, and is widely used for fixed bracket locks and compact locks.



**EASY WRAP CABLE**

A coil and straight hybrid cable. It can be stored compactly using the coil part.

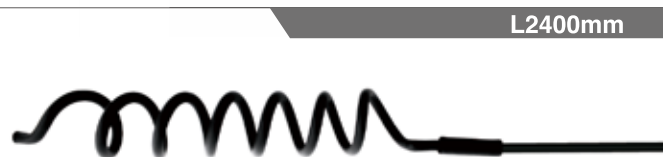

**DOUBLE WIRE CABLE**

The cable bundled with two wires has high resistance to cutting, and can be stored smoothly because it is hard to twist.

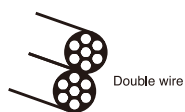

**STRAIGHT CABLE**

Effective for locking front and rear wheels and locking multiple bikes without entanglement with spokes.



\* The above length is the total length including the head.





CROPS  
**LIGHTS**



rev up the ideas



DAY RIDE  
MODES

When using the day-time flashing mode during the day, the light automatically switches from day-time flashing to constant when entering dark areas such as tunnels.

SPORTS MODEL



rev™ 900  
ALUMINIGHT

USB (Type-C) chargeable  
Full charge : Approx 5 hrs.  
Battery indicator / Low voltage indicator  
Brightness : Approx 900 lumens

High mode (900lm) : Approx 2.5 hrs.  
Middle mode (400lm) : Approx 4 hrs.  
Low mode (200lm) : Approx 7 hrs.  
Day time flash (200/50lm) : Approx. 24 hrs.  
Flashing (100lm) : Approx 46 hrs.

Product code	Color	LED	Battery	Weight (g)
C1R06-01-0100	Black	LED x 1	LI-Ion 3.7V / 2600mAh	150 (Battery included)

Parts : USB (Type -C) cable / Ultifix™ bracket "ZP-UBX02-LM"  
GP MOUNT "ZP-GPM01LM"



rev™ 600  
ALUMINIGHT

USB (Type-C) chargeable  
Full charge : Approx 5 hrs.  
Battery indicator / Low voltage indicator  
Brightness : Approx 600 lumens

High mode (600lm) : Approx 3 hrs.  
Middle mode (300lm) : Approx 6 hrs.  
Low mode (200lm) : Approx 9 hrs.  
Day time flash (200/50lm) : Approx. 27 hrs.  
Flashing (100lm) : Approx 48 hrs.

Product code	Color	LED	Battery	Weight (g)
C1R05-01-0094	Black	LED x 1	LI-Ion 3.7V / 2600mAh	150 (Battery included)

Parts : USB (Type -C) cable / Ultifix™ bracket "ZP-UBX02-LM"  
GP MOUNT "ZP-GPM01LM"



The flagship model rev1200 is equipped with a high-capacity 5200mAh battery, which provides high-power illumination of approximately 1200 lumens for a long ride. It is a powerful tool that can brightly illuminate the surroundings on roads with few streetlights, etc. and provide riders with more information on visibility, road conditions, etc.



## rev<sup>TM</sup>1200 ALUMINIGHT

USB (Type-C) chargeable  
Full charge : Approx 7- 8 hrs.  
Battery indicator / Low voltage indicator  
Brightness : Approx 1200 lumens

High mode (1200lm) : Approx 2.5 hrs.  
Middle mode (600lm) : Approx 4 hrs.  
Low mode (300lm) : Approx 6 hrs.  
Day time flash (300/50lm) : Approx. 26 hrs.  
Flashing (200lm) : Approx 60 hrs.

Product code	Color	LED	Battery	Weight (g)
C1R07-01-0117	Black	LEDx2	LI-Ion 3.7V / 5200mAh	227 (Battery included)

Parts : USB (Type -C) cable / Ultifix™ bracket "ZP-UBX02-LM"



## URBAN MODEL



## rev<sup>TM</sup>500

USB (Type-C) chargeable  
Full charge : Approx 4 hrs.  
Battery indicator / Low voltage indicator  
Brightness : Approx 500 lumens

High mode (500lm) : Approx 3.5 hrs.  
Low mode (150lm) : Approx 8.5 hrs.  
Day time flash (200/50lm) : Approx. 19 hrs.  
Flashing (100lm) : Approx 43 hrs.

Product code	Color	LED	Battery	Weight (g)
C1R02-01-0025	Black	LEDx1	LI-Ion 3.7V / 2600mAh	108 (Battery included)

Parts : USB (Type -C) cable / Ultifix™ bracket "ZP-UBX02-LM"  
GP MOUNT "ZP-GPM01LM"



## rev<sup>TM</sup>300

USB (Type-C) chargeable  
Full charge : Approx 4 hrs.  
Battery indicator / Low voltage indicator  
Brightness : Approx 300 lumens

High mode (300lm) : Approx 4.5 hrs.  
Low mode (150lm) : Approx 5.5 hrs.  
Day time flash (100/50lm) : Approx. 27 hrs.  
Flashing (100lm) : Approx 53 hrs.

Product code	Color	LED	Battery	Weight (g)
C1R01-01-0018	Black	LEDx1	LI-Ion 3.7V / 2200mAh	108 (Battery included)

Parts : USB (Type -C) cable / Ultifix™ bracket "ZP-UBX02-LM"  
GP MOUNT "ZP-GPM01LM"

rev<sup>TM</sup>  
series

The rev150 eco-friendly urban Headlight that can be recharged directly to rechargeable batteries



The use of rechargeable batteries is more cost-effective than the dry cell type, and the eco-friendly specification reduces battery waste.



NI-MH AA x 2



USB TYPE-C



DAY TIME FLASH



MODE MEMORY



WATER PROOF



ULTIFIX™

## URBAN MODEL



rev<sup>TM</sup>150

USB (Type-C) rechargeable  
Full charge : Approx 5.5 hrs.  
Battery indicator / Low voltage indicator  
Brightness : Approx 150 lumens

High mode (150lm) : Approx 2 hrs.  
Low mode (100lm) : Approx 4 hrs.  
Day time flash (100/50lm) : Approx. 5.5 hrs.  
Flashing (70lm) : Approx 38 hrs.

Product code	Color	LED	Battery	Weight (g)
C1R03-01-0032	Black	LED x 1	Ni-MH 1.2V / AAx2	113 (Battery included)
C1R03-17-0049	Gray			

Parts : Rechargeable to AA Ni-MH batteries x 2 / USB (Type -C) cable  
Ultifix™ bracket "ZP-UBX02-LM"



USB TYPE-C



NI-MH AA x 2



Rechargeable with USB (Type-C)

rev150 can be use with rechargeable batteries (Ni-MH) or to use general dry batteries (AA x 2)  
\*Ni-MH batteries are for rechargeable, but do not charge the general dry batteries

### STARTER KIT

Product code	Color
C4K01-01-0551 (Black)	Black
C4K01-17-0568 (Gray)	Gray



rev<sup>TM</sup>150



LED SOLAR LIGHT  
80JSRV-USB



ZP-RB12-18  
SEAT STAY BRACKET



ZP-RBF02  
MUDGUARD MOUNT

Suitable for urban rides with 240lumens light with TOP CUT line design on the lens

## Lum240mu

Micro USB chargeable / Full charge : Approx 5 hrs.  
 Battery indicator / Low voltage indicator  
 Brightness : Approx 240 lumens

High mode : Approx 2 hrs.  
 Low mode : Approx 5 hrs.  
 Flashing : Approx 11 hrs.



Product code	Color	LED	Battery	Weight (g)
C1L03-01-9336	Black	3 Watts LED x 1	Li-ion 3.7V / 1800mAh	118 (Battery included)

Parts : Micro USB cable / Universal bracket "ZP-UB07"



## Lum240mu

WIDE ANGLE LIGHT BEAM



Option

Long lasting constant specification  
 Total of 64g unit fits for long ride

## Lum120mu

Micro USB chargeable / Full charge : Approx 2.5 hrs.  
 Battery indicator / Low voltage indicator  
 Brightness : Approx 120 lumens

High mode : Approx 6 hrs.  
 Low mode : Approx 11 hrs.  
 Flashing : Approx 22 hrs.



Product code	Color	LED	Battery	Weight (g)
C1L02-01-9329	Black	1 Watt LED x 1	Li-ion 3.7V / 1000 mAh	64 (Battery included)

Parts : Micro USB cable / Universal bracket "ZP-UB07"

## Lum120mu

WIDE ANGLE LIGHT BEAM



Option

Using reflecting light to create TOP CUT wide beam and allowing a parallel square light that does not blind pedestrians and oncoming drivers

## Lum100mu

Micro USB chargeable / Full charge: Approx 2.5hrs.  
 Battery indicator / Low voltage indicator  
 Brightness: Approx 100lumens

High mode : Approx 3.5 hrs.  
 Low mode : Approx 7 hrs.  
 Flashing : Approx 20 hrs.



K-mark



Product code	Color	LED	Battery	Weight (g)
C1L01-01-9312	Black	1 Watt LED x 1	Li-ion 3.7V / 1000 mAh	55 (Battery included)

Parts : Micro USB cable / Universal bracket "ZP-UB07"



## Lum100mu





WIDE ANGLE LIGHT BEAM



Option





-   
BATTERY  
AA x 2
-   
DAY TIME FLASH
-   
MODE MEMORY
-   
WATER PROOF
-   
ULTIFIX™
-   
ULTIFIX™  
OPTION PARTS :  
BLB-KN

# VISO BELL COMBO

CROPS has released a new battery-powered (2 x AA) light specifically designed for entry-level users. It provides a brightness of approximately 150 lumens, offering sufficient illumination despite its compact size. The body is constructed with polycarbonate, ensuring durability. Additionally, it features CROPS' original universal bracket, called "UltiFix," which allows for the attachment of the original bell. This design combination allows the bell to be seamlessly integrated with the bracket, resulting in a discreet appearance.

## ENTRY MODEL



### VISO

Battery indicator / Low voltage indicator  
Brightness : Approx 150 lumens

● ○ ● ● ●

High mode (150lm) : Approx 9 hrs.  
Low mode (70lm) : Approx 14 hrs.  
Day time flash (150/50lm) : Approx. 17 hrs.  
Flashing (70lm) : Approx 30 hrs.



### VISO BELL COMBO

Battery indicator / Low voltage indicator  
Brightness : Approx 150 lumens

● ○ ● ● ●

High mode (150lm) : Approx 9 hrs.  
Low mode (70lm) : Approx 14 hrs.  
Day time flash (100/50lm) : Approx. 17 hrs.  
Flashing (70lm) : Approx 30 hrs.

Product code	Color	LED	Battery	Weight (g)
C1R04-01-0063	Black			
C1R04-02-0070	White			
C1R04-03-0087	Blue	LED x 1	AA x 2	110 (Battery included)
C1R04-17-0230	Gray			
C1R04-33-0247	Gravel green			

Parts : Ultifix™ bracket "ZP-UBX02-LM"

Product code	Color	LED	Battery	Weight (g)
C1R04-01b-0193	Black			
C1R04-02b-0254	White			
C1R04-03b-0261	Blue	LED x 1	AA x 2	127 (Battery included)
C1R04-17b-0278	Gray			
C1R04-33b-0285	Gravel green			

Parts : Ultifix™ bracket "ZP-UBX02-LM" / BELL knob "ZP-BLB-KN"



Waterproof light designed specifically for underside mounting

## SX9CWS

Low voltage indicator  
 Brightness : Approx 100 lumens / 2000 cd  
 \*Alkaline batteries recommended

High mode : Approx 25 hrs.  
 Low mode : Approx 45 hrs.  
 Flashing : Approx 65 hrs.



Product code	Color	LED	Battery	Weight (g)
C1S03-01-9725	Black	1Watt LED x 1	AAA x 3	80 (Battery included)
C1S03-02-9732	White			

Parts : Universal bracket "ZP-UB07"



SX9CWS  
1Watt

## SX8CWS

Low voltage indicator  
 Brightness : Approx 100 lumens / 2000 cd  
 \*Alkaline batteries recommended

High mode : Approx 25 hrs.  
 Low mode : Approx 45 hrs.  
 Flashing : Approx 65 hrs.



Product code	Color	LED	Battery	Weight (g)
C1S02-01-9718	Black	1Watt LED x 1	AAA x 3	69 (Battery included)

Parts : Universal bracket "ZP-UB07"

SX8CWS  
1Watt

100Lumens high performance battery light



## SX8CW

Low voltage indicator  
 Brightness : Approx 40 lumens / 1000 cd  
 \*Alkaline batteries recommended

Constant : Approx 25hrs.  
 Flashing : Approx 50hrs.



Product code	Color	LED	Battery	Weight (g)
C1S01N-01-0124	Black			
C1S01N-02-0131	White	LED x 1	AAA x 3	69 (Battery included)
C1S01N-07-0148	Silver			

Parts : bracket "ZP-FB22-28N"



SX8  
CW

Three colors to choose from to match your bicycle

## SX7CW

Low voltage indicator  
 Brightness : Approx 30 lumens / 1000 cd  
 \*Alkaline batteries recommended

Constant : Approx 90 hrs.  
 Flashing : Approx 175 hrs.



Product code	Color	LED	Battery	Weight (g)
C1S04-01-9923	Black	LED x 3	AA x 3	109 (Battery included)

Parts : bracket "ZP-FB22-28N"



SX7  
CW

Bright With 3LED and Long-lasting Battery



# BL600mu

BUILT-IN ACCELEROMETER FOR BRAKING



## BL600mu

Micro USB chargeable / Full charge: Approx 2.5 hrs.  
Battery indicator / Low voltage indicator

Constant : Approx 4.5 hrs.  
Flashing 1 : Approx 8.5 hrs.  
Flashing 2 : Approx 8.5 hrs.



Product code	Color	LED	Battery	Weight (g)
C2E02-04-9374	RED	Red LED x 1+ COB LED	Li-Ion 3.7V / 320 mAh	28

Parts : Micro USB cable / Universal bracket " ZP-UB08 "



## TL600mu

Micro USB chargeable / Full charge : Approx 2.5 hrs.  
Battery indicator / Low voltage indicator

Constant : Approx 4 hrs.  
Flashing 1 : Approx 5.5 hrs.  
Flashing 2 : Approx 5.5 hrs.



Product code	Color	LED	Battery	Weight (g)
C2E03-13-9367	CLEAR	Red LED x 1+ Umber LED x 6	Li-Ion 3.7V / 320m Ah	28 / 16 (Light / Controller) (Battery included)

Parts : CR2032(Controller)x1 / Micro USB cable / Saddle rail bracket " ZP-FBST01 "



Short charging time of about 1 hour

## scenes SC100W

USB(Type-C) chargeable / Full charge: Approx 70 min.  
Battery indicator  
Brightness : Approx 37 lumens

Constant 1 : Approx 4.5 hrs.  
Constant 2 : Approx 9 hrs.  
Speed Flashing : Approx 15 hrs.  
Slow Flashing : Approx 9 hrs.



Product code	Color	LED	Battery	Weight (g)
C1SC02-13-0605	CLEAR	White LED x 35	Li-Ion 3.7 V / 380 mAh	23

Parts : USB (Type-C) cable / Univeasal bracket" ZP-UB08"



Short charging time of about 1 hour

## scenes SC100R

USB(Type-C) chargeable / Full charge: Approx 70 min.  
Battery indicator

Constant 1 : Approx 4 hrs.  
Constant 2 : Approx 7.5 hrs.  
Speed Flashing : Approx 14 hrs.  
Slow Flashing : Approx 8 hrs.



Product code	Color	LED	Battery	Weight (g)
C1SC02-04-0599	RED	Red LED x 35	Li-Ion 3.7V / 380 mAh	23

Parts : Micro USB cable / Universal bracket " ZP-UB08 "





MULTI-PURPOSE SAFETY LIGHT  
**SCENES™**  
 Lights that illuminates even while charging

**8 Modes**



Lightweight, Flat Body for Flexible Installation

The clip and hard bracket design allows the light to be mounted in various locations, including places other than the seat post or handlebars. The flat body reduces light shaking caused by vibration while riding.



Hooked saddlebag



Backpack



Helmet



Safety light



Emergency hand light

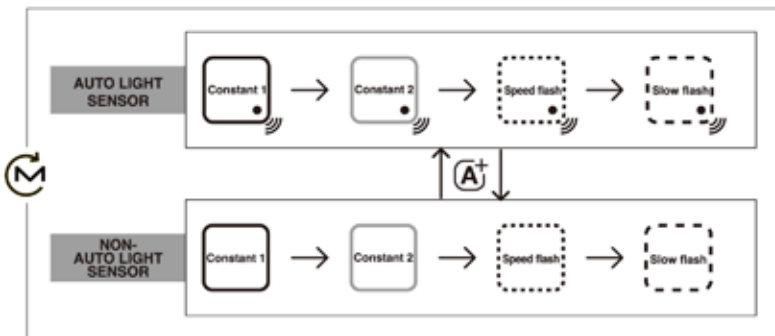

**8 Modes**

A-link as such as to double-click the switch to change the modes between Auto light sensor and Non-Auto light sensor. Each mode has 4 different functions as 100% Constant, 50% Constant, Speed flashing, and Slow flashing.

MULTI-PURPOSE SAFETY LIGHT

This product can be use Non-auto sensor functions while charging the battery.

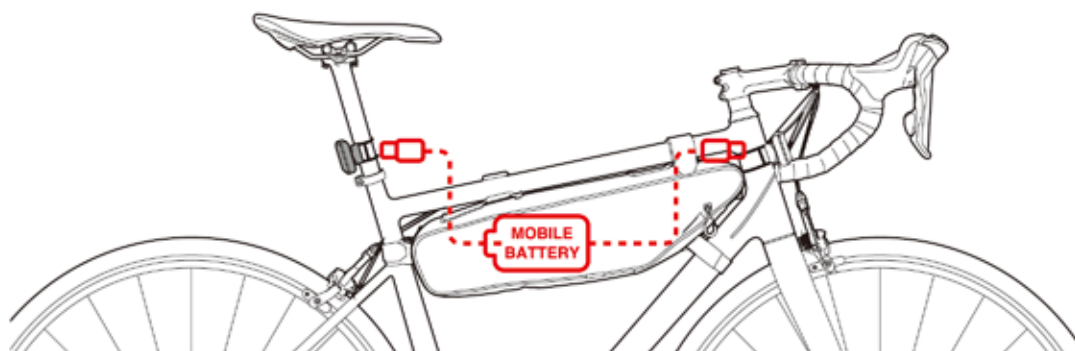



## EZ500mu-SPORTS

※Transparent body to be seen 360°  
 Micro USB chargeable  
 Full charge : Approx. 2hrs.  
 Battery indicator

Constant : Approx 5.5 hrs.  
 Flashing : Approx 15 hrs.  
 Chase flash : Approx 30 hrs.



## EZ500mu-SPORTS

AUTO LIGHT SENSOR

Product code	Color	LED	Battery	Weight (g)
C2E04-01-0575	Black	Red LED x 5	Li-ion 3.7V / 320mAh	22 (Battery included)
C2E04-04-0582	Red			

Parts : USB (Type-C) cable / Universal bracket "ZP-UB08"



ZP-UB08 bracket for wide range fixation



Universal mount bracket  
ZP-UB08



## EZ1-SPORTS

Constant : Approx 200 hrs.  
 Flashing 1 : Approx 300 hrs  
 Flashing 2 : Approx 360 hrs.



## EZ1-SPORTS

Product code	Color	LED	Battery	Weight (g)
CPEZ1RNU-018CR	Black	Red LED x 1	CR2032 x 1	11 (Battery included)

Parts : Universal bracket "ZP-UB08"



CLICK BODY



ZP-UB08 bracket for wide range fixation



Universal mount bracket  
ZP-UB08





# FULL FACE REAR FLASHER WITH REFLECTOR

BRIGHT! SAFETY LIGHT THAT SHINES THROUGH THE ENTIRE LENS



- This product does not need to replace battery regularly
- Auto flashing by vibration and dark sensor
- Flash for approx. 1 minute 30 seconds after stop

For seat stay  
\* The pipe diameter that can be attached is limited to circular pipes of  $\phi 12 - 18\text{mm}$ .

## Easy removal



For mudguard mount  
\* It is limited to mudguard, which the rear light can be attached.

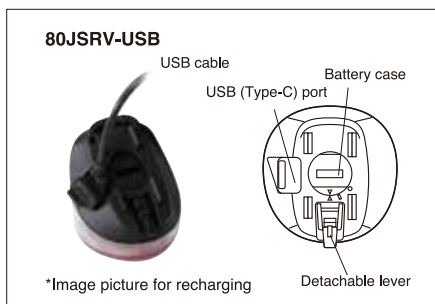

Full face rear flasher with reflector + USB  
**80JSRV-USB** (Type-C rechargeable)  
Full face rear flasher with reflector  
**80JSRV-NUSB** (Non-rechargeable)

- Function : Flashing mode : Approx 50 hrs. • Full charge : Approx 1.5 hrs. • Solar charge : Approx. 4hrs.
- Waterproof

Product name	Product code	Color	LED	Battery	Weight (g)
<b>80JSRV-USB</b>	<b>C2T02-04-0377</b>	Red	Red LED x 1	200 mAh Ni-MH 1.2V / 200mAh	38 (Battery included)
• USB (Type-C) cable / Mudguard mount "ZP-RBF02" / Seat stay bracket "ZP-RB12-18" are included					
<b>80JSRV-NUSB</b>	<b>C2T03-04-0384</b>	Red	Red LED x 1	200 mAh Ni-MH 1.2V / 200mAh	38 (Battery included)
• Mudguard mount "ZP-RBF02" / Seat stay bracket "ZP-RB12-18" are included					

**LIGHT PARTS**

**FB22-28N BOLT ON BRACKET**

Product code	Size (Handlebar diameter)	Weight (g)
ZP-FB22-28N (XCC)	φ 22 ~ 28	22



**FB32 BOLT ON BRACKET**

Product code	Size (Handlebar diameter)	Weight (g)
ZP-FB32	φ 32	22



**UB07 UNIVERSAL BRACKET**

Product code	Size (Handlebar diameter)	Weight (g)
ZP-UB07	φ 22 ~ 32	9

Included silicon band, rubber pad, and double side tape



**UB09-LM UNIVERSAL BRACKET**

Product code	Size (Handlebar diameter)	Weight (g)
ZP-UB09-LM	φ 22 ~ 35	12

For : rev series



**UBX02-LM UNIVERSAL BRACKET**

Product code	Size (Handlebar diameter)	Weight (g)
ZP-UBX02-LM	φ 22 ~ 35	23

For : rev series



**UBX02LM-BLB UNIVERSAL BRACKET**

Product code	Size (Handlebar diameter)	Weight (g)
ZP-UBX02LM-BLB	φ 22 ~ 35	-

For : rev series



**HB01 HELMET BRACKET**

Product code	Weight (g)
ZP-HB01	



**UB07PT UB07 REPAIR PARTS**

Product code	Weight (g)
ZP-UB07PT	3



**BLB-KN BELL (BRASS)**

Product code	Weight (g)
ZP-BLB-KN	-

\*Compatible with UltiFix™



**GPM01LM GP MOUNT**

Product code	Weight (g)
ZP-GPM01LM	-

Included bolt, washer  
For : rev series



**HSPB02 HEAD SPACER BRACKET**

Product code	Size (Handlebar diameter)	Weight (g)
ZP-HSPB02	φ 28.6	26



**BX2 HUB LAMP HOLDER**



Hub lamp holder : For 3/8" shaft or 5/16" shaft  
Material: Aluminum alloy

Product code	Color	Size (φ x L mm)	Weight (g)
CP-BX2	Silver	25 x 42	42



# UB08 UNIVERSAL BRACKET

	Name	Parts no.	Product code
Combo	Basic / All parts	1 · 2 · 3 · 4 · 5	ZP-UB08
	Basic / Short band type	1 · 2 · 3 · 4	ZP-UB08 - A TYPE
	Basic / Long band type	1 · 3 · 5	ZP-UB08 - B TYPE



## ZP-UB08

### Parts

- 1 BASE / ZP-UB08 - BASE
- 2 Normal pad / ZP-UB08 - NP
- 3 Aero pad / ZP-UB08 -AP
- 4 Short band / ZP-UB08 - SB
- 5 Long band / ZP-UB08 - LB

# FBST01 SADDLE RAIL BRACKET

Product code	Size (Saddle rail diameter)	Weight (g)
ZP-FBST01	φ 6 ~ 8	17

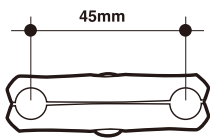

## RB12-18 SEAT STAY BRACKET

Product code	Size (Pipe diameter)	Weight (g)
ZP-RB12-18	φ 12 ~ 18	18

Included spacer, rubber pad  
For : 80JSRV / 80JSRV-USB / 80JSRV-NUSB



## RBF01 MUDGUARD MOUNT

Product code	Weight (g)
ZP-RBF01	

For : 80JSRV / 80JSRV-USB / 80JSRV-NUSB



## RBF02 MUDGUARD MOUNT

Product code	Weight (g)
ZP-RBF02	14

For : 80JSRV / 80JSRV-USB / 80JSRV-NUSB



## Button cell battery : B80H REPAIR PARTS

Product code	Battery	Weight (g)
ZP-B80H	Ni-MH 1.2V / 80 mAh	3

For : 80JSRV



## Rechargeable battery : B200H REPAIR PARTS

Product code	Battery	Weight (g)
ZP-B200H	Ni-MH 1.2V / 200 mAh	4

For : 80JSRV-USB / 80JSRV-NUSB

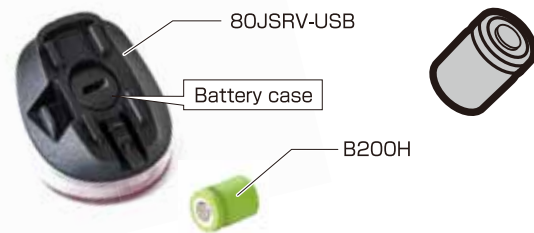

## LOCK PARTS

### BKT006N UNIVERSAL BRACKET

Product code	Size (Pipe diameter)	Weight (g)
ZP-BKT006N	φ 22 ~ 40	44



### BKT007 BRACKET

Product code	Size (Pipe diameter)	Weight (g)
ZP-BKT007	φ 25 ~ 38	110 (Strap included)

Included Strapx2, phillips head screwsx2  
For : BENLOCK



### Strap : BKT007-S50 BKT007 REPAIR PARTS

Product code	Size (Pipe diameter)	Weight (g)
ZP-BKT007-S50	φ 40 ~ 55	-

For : BENLOCK



### BKT007K BRACKET

Product code	Size (Pipe diameter)	Weight (g)
ZP-BKT007K	φ 25 ~ 38	110 (Strap included)

Included Strapx2, phillips head screwsx2  
For : K4-CABRIO / K5-CABRIO





Synchronise the front and rear lights  
**SYNCH LIGHTS SYSTEM**

700HDRJ2-CV-70+80JSRV-CV-HUB				
TAILLIGHT	SEAT STAY BRACKET	EXTENSION CABLE	HEAD SPACER BRACKET	HEAD LIGHT
80JSRV-CV-HUB	NP-RB12-18		NP-HSPB02 / NP-9S	700HDRJ2-CV-70

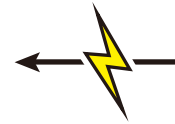
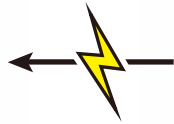

**HUB DYNAMO LIGHT COMBO**

Product name	Spec.	Brightness	Function	Power spec.	Cable spec. / Battery spec. / Cable length
700HDRJ2-CV-70+80JSRV-CV-HUB	0.5 Watt White LED	2000 cd	Auto sensor	6V / 2.4 Watt	J2 Connector / Length 65 cm

BICYCLE PARTS

	Product name	Spec.	Brightness	Function	Power spec.	Cable spec. / Battery spec. / Cable length
HUB DYNAMO HEAD LIGHT	<b>800HDJ2-70</b>	0.5Watt White LED	2500 cd	Auto sensor	6V / 0.8~2.4 Watt	J2 Connector / Length 65 cm
HUB DYNAMO HEAD LIGHT	<b>700HDJ2-70</b>	0.5Watt White LED	2000 cd	Auto sensor	6V / 0.8~2.4 Watt	J2 Connector / Length 65 cm
SOLAR TAILLIGHT	<b>80JSRV</b>	Red LED x 1		Solar light	1.2V, 80 mAh	B80H (NIMH)

E-BIKE PARTS

	Product name	Spec.	Brightness	Function	Power spec.	Cable spec. / Battery spec. / Cable length
E-BIKE HEAD LIGHT	<b>800JDC6-36</b>	1 Watt White LED	5000 cd	Auto sensor	DC 6 - 36 V	S. Steps connector / Length : Head cable : 15 cm / S.Steps cable 100 cm
E-BIKE HEAD LIGHT	<b>700JDC6-36</b>	0.5 Watt White LED	2000 cd	Auto sensor	DC 6 - 36 V	S. Steps connector / Length : Head cable : 15 cm / S.Steps cable 100 cm
E-BIKE TAILLIGHT	<b>80JDC6-36</b>	Red LED x 1		Flash / Brake light	DC 6 - 36 V	S. Steps connector / Length 80 cm

**BRACKET & PARTS**

Column mount Center fork bracket		Center fork bracket	Basket bracket		Front fork bracket	Mudguard mount		Seat Stay bracket parts		
ZP-HSPB02	ZP-8CW	NP-8CW	NP-BB	NP-CB02BB	NP-9S	ZP-RBF01	ZP-RBF02	ZP-RB12-18	NP-S12	NP-RB-D



The simultaneous lights (Head and tail lights) that do not have to worry for running out of power at night ride

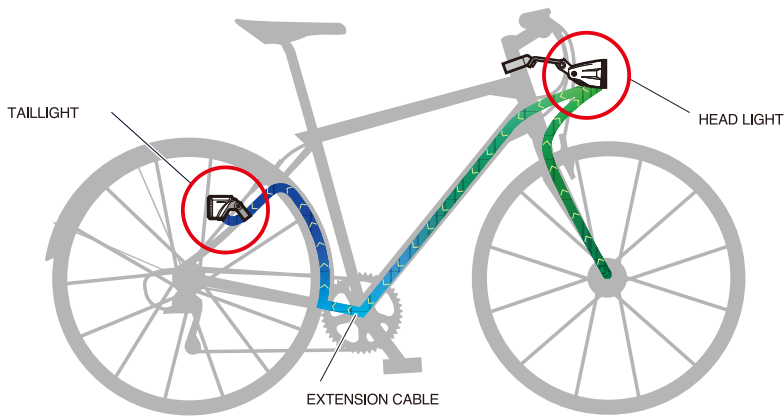

HUB DYNAMO HEAD LIGHT  
**800HDJ2-70**

BRACKET TYPE : NP-HSPB02 NP-8CW  
NP-BB NP-CB02BB NP-9S



HUB DYNAMO HEAD LIGHT  
**700HDJ2-70**

BRACKET TYPE : NP-HSPB02 NP-8CW  
NP-BB NP-CB02BB NP-9S



SOLAR TAILLIGHT for SEAT STAY  
**80JSRV**

BRACKET TYPE : NP-RBF01 NP-RBF02  
NP-RB12-18 NP-RB-D

Cable fixing plate for fender	Silicone strap for cable	J2 terminal conversion adapter	Extension cable
 SFCP48-26   SFCP4858-20	 NP-SCB1070	 HP-ADAPTER   SS-ADAPTER	<b>E-BIKE LIGHT</b> JST Head Terminal Cable L : 1500 mm
			<b>E-BIKE LIGHT</b> SS Head Terminal Cable L : 1000 mm
			<b>HUB DYNAMO LIGHT</b> Bullet Heads Terminal Cable L : 1500 mm

E-BIKE PARTS



SHIMANO STEPS IN MOUNT BATTERY LOCK  
Made in Taiwan

**SMBME-8030**

Weight : 99 g | Parts : Dimple keys x 3



SHIMANO STEPS OUTER BATTERY LOCK  
Made in Taiwan

**SMBME-JP**

Weight : 170 g | Parts : Dimple keys x 3

SHIMANO STEPS OUTER BATTERY LOCK  
Made in China

**SMBME-CN**

Weight : 170 g | Parts : Flat keys x 3



E-BIKE HEAD LIGHT

**CP-KW2880-15** DC 5.5 V / 0.8 W



E-BIKE HEAD LIGHT

**800JDC6-36**

NP-HSPB02 NP-8CW NP-BB NP-CB02BB NP-9S



E-BIKE TAILLIGHT

**80JDC6-36**

NP-RBF01 NP-RBF02 NP-RB12-18 NP-RB-D



FOLDABLE ULOCK  
**benlock™**

**CROPS**



**benlock**  
 The foldable U-lock



2023 WINNER

**K5 series**  
 5 digits combination lock



2012 WINNER

**benlock**  
 The foldable U-lock



**GOOD DESIGN  
 AWARD 2023**



Official site



e-catalog

**CROPS Co., Ltd.**  
 www.crops-sports.com

1-1-24, Honmachi, Hyogo-ku, Kobe, 6520834 Japan

- Suggested retail prices are subject to change without prior notice due to fluctuation in material prices, exchange rates, etc.
- Product descriptions are effective as of June 2024.
- Specifications and product designs that appear in this catalog are subject to change without prior notice due to product improvement.
- The size and weight indicated may vary depending on method of measurement and the individual difference.

2024.06